

6-GFM-100Ah



Valve-regulated Lead Acid Battery Specification

Features

- Maintenance free
- Safety and no leakage
- Excellent recharge and discharge performance
- Low self-discharge rate
- Adapt to high or low temperature
- Good deep discharge performance
- Longer cycle life



Specification

Rated Voltage	12V
Numbers of cells	6 Cells
Capacity	100Ah@10hr-rate to 1.80V per cell @25°C
Weight	28.3kg
Internal Resistance	Approx. 4.5 mΩ
Terminal	F8
Max. Discharge Current	1500A(5s)
Short Circuit Current	5000A
Max. Charging Current	25A
Reference Capacity	C10 100AH C3 76.8AH C1 55.2AH
Design Life	10~15 years
Float Charging Voltage	13.5 V-13.8 V @ 25°C Temperature Compensation: -20mV/°C/Cell
Cycle Use Voltage	14.4 V-15 V @ 25°C Temperature Compensation: -30mV/°C/Cell
Operating Temperature Range	Discharge: -20°C-60°C Charge: 0°C-50°C Storage: -20°C-60°C
Normal Operating Temperature Range	25°C±5°C
Self Discharge	Less than 3% at 25°C per month
Container Material	A.B.S. UL94-HB, UL94-V0 Optional.

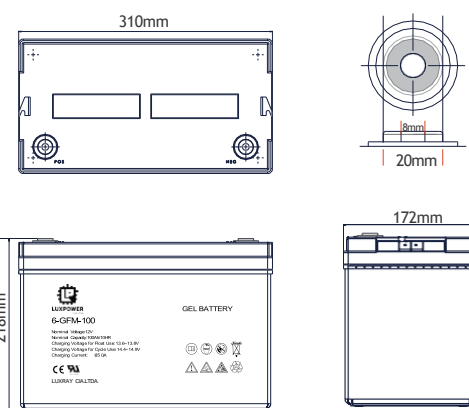

Length	310±2mm (12.2 inches)
Width	172±1mm (6.8 inches)
Height	215±1mm (8.5 inches)
Total Height	218±1mm (8.6 inches)

Constant Current Discharge Characteristics: A(25°C)

F.V/Time	5min	10min	15min	20min	30min	45min	1h	3h	5h	10h	20h
1.80V/cell	229.8	171.9	138.2	113.1	89.8	67.0	52.8	25.6	16.8	10.0	5.20
1.75V/cell	259.0	188.9	151.0	121.7	93.2	69.4	55.2	26.0	17.2	10.1	5.26
1.70V/cell	285.2	205.9	161.2	127.9	97.0	72.2	57.0	26.8	17.7	10.2	5.36
1.65V/cell	314.6	222.2	171.4	135.9	102.3	74.1	58.9	27.9	18.1	10.4	5.42
1.60V/cell	346.9	241.2	183.3	144.8	108.0	77.2	61.0	28.8	18.8	10.5	5.46

Constant-power discharge parameter Unit: W(25°C)1

F.V/Time	5min	10min	15min	20min	30min	45min	1h	3h	5h	10h	20h
1.80V/cell	415.6	313.9	254.6	210.1	168.4	127.7	101.3	49.6	32.8	19.8	10.29
1.75V/cell	458.6	339.3	274.6	223.9	173.4	131.2	105.6	50.2	33.6	19.9	10.37
1.70V/cell	491.0	361.4	289.1	233.6	179.6	136.0	108.4	51.6	34.3	20.1	10.57
1.65V/cell	533.8	386.6	305.0	246.2	187.9	138.1	111.3	53.4	35.1	20.4	10.69
1.60V/cell	575.1	410.1	320.8	259.4	196.9	143.2	114.7	54.9	36.1	20.7	10.73

6-GFM-100Ah

Valve-regulated Lead Acid Battery Specification

Charge Characteristics for Float Use @ 25°C/77°F

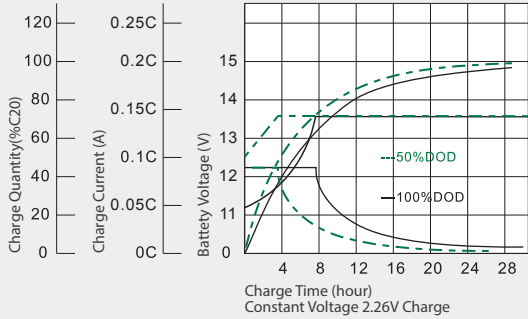

Discharge Characteristics at Various Rates @ 25°C/77°F

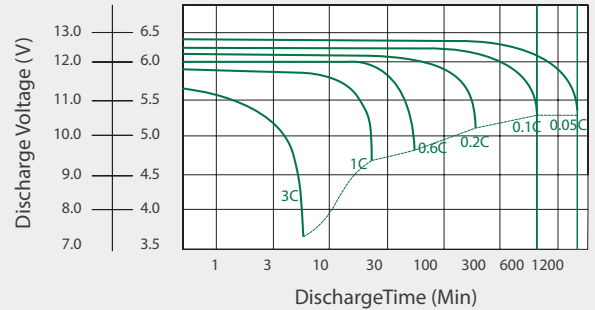

Cycle Life in Relation to Depth of Discharge

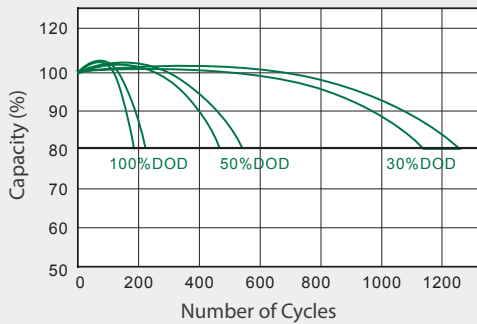

Float Service Life

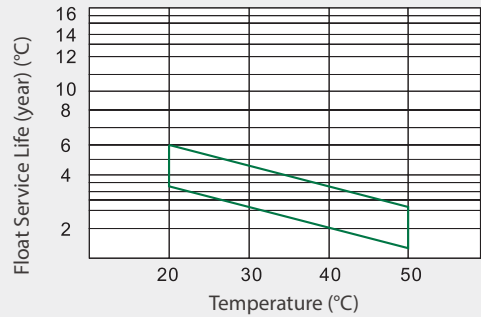

Temperature and Valid Capacity

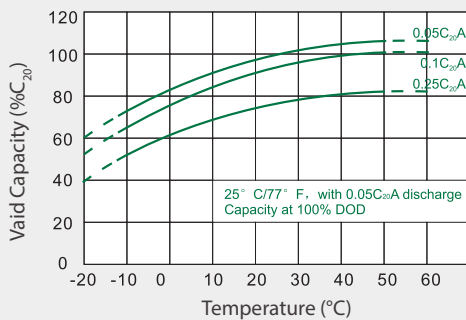

Self Discharge Characteristics

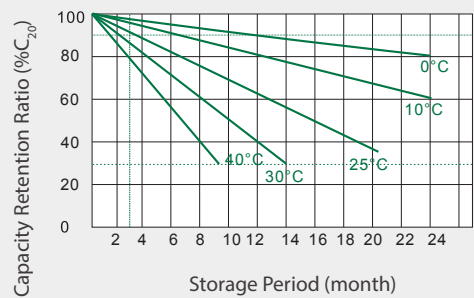

Capacity and Open Circuit Voltage

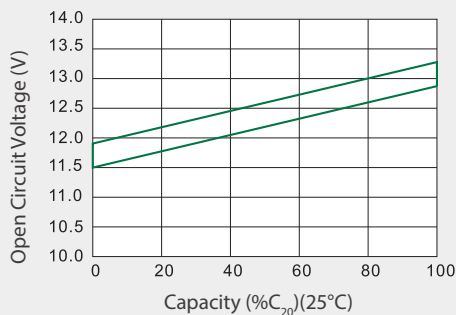

Relationship between Charging Voltage and Temperature

